



**IDEAL INDUSTRIES INC.
TECHNICAL MANUAL
MODEL 61-096 Split Jaw Smart Meter**

The Service Information provides the following information :

- Precautions and safety information
- Specifications
- Basic maintenance (cleaning, replacing the battery and fuses)
- Performance test procedures
- Calibration and calibration adjustment procedures



Form Number: TM61096

Revision: 2. Date: Nov 2010

TABLE OF CONTENTS Page

Introduction	1
Precautions and Safety Information	1
Symbols	1
Safety	2
Specifications	3
General Specification	3
Voltage Specification	4
Resistance & Continuity Specification	4
Current Specification	4
Physical and environment characteristics	5
Certification and compliance	5
Required Equipment	6
Basic Maintenance	7
Opening the Meter Case	7
Replacing the Battery	7
Performance Tests	8
Testing the Voltage Function	8
Testing the Resistance Function	9
Testing the AC Current Function	10
Calibration	11
Calibrating DCV, ACV, Resistance, ACA Functions	11
Calibration Adjustment Points	12/13

Introduction

Warning

To avoid shock or injury, do not perform the verification tests or calibration procedures described in the manual unless you are qualified to do so.

The information provided in this document is for the use of qualified personnel only.

Caution

The 61-096 contain parts that can be damaged by static discharge.

Follow the standard practices for handling static sensitive devices.

For additional information about IDEAL INDUSTRIES, INC. and its products, and services, visit IDEAL INDUSTRIES, INC. web site at:

www.idealindustries.com

Precautions and Safety Information









Use the Meter only as described in the Service Manual. If you do not do so, the protection provided by the Meter may be impaired. Read the "Safety Information" page before servicing this product.

In this manual, a **Warning** identifies conditions and actions that pose hazard (s) to the user; a **Caution** identifies conditions and actions that may damage the Meter or the test instruments.

The Symbols

The symbols used on the Meter and in this manual are explained in Table 1.

Table A. The Symbols

	Risk of electric shock
	See instruction card
	DC measurement
	Equipment protected by double or reinforced insulation
	Battery
	Earth
	AC measurement
	Conforms to EU directives

SAFETY

Review the following safety precautions to avoid injury and prevent damage to this product or products connected to it. To avoid potential hazards, use the product only as specified.

⚠CAUTION: These statements identify conditions or practices that could result in damage to the equipment or other property.

⚠WARNING: These statements identify conditions or practices that could result in personal injury or loss of life.

Specific precautions

Do not operate without covers. To avoid personal injury, do not apply any voltage or current to the product without covers in place.

Electric overload. Never apply a voltage to a connector on the product that is outside the range specified for that connector.

Avoid electric shock. To avoid injury or loss of life, do not connect or disconnect probes or test leads while they are connected to a voltage source.

Do not operate in wet/damp conditions. To avoid electric shock, do not operate this product in wet or damp conditions.

SPECIFICATIONS

All specifications are warranted unless noted typical and apply to the 61-096

Stated accuracies are at 23°C±5°C at less than 80% relative humidity and without the battery indicator displayed.

General specifications

Characteristics	Description
Display count	6000
Numeric update rate	5 times / sec
Polarity display	Automatic
Overrange display	"OL" is display
Low voltage indicator	 is indicated
Automatic power-off time	Automatic backslit off = 30 minutes
Power source	Power 9V battery
Maximum input voltage	1000V CAT III between V and COM
Maximum floating voltage	1000V CAT III between any terminal and earth ground
V connector	V ~, V ---, Ω, °))
Temperature Coefficient	0.2×(Spec. Accuracy) / °C, <18°C or >28°C
Battery Life	180 hours typical (alkaline)

Measurement Characteristics

Accuracy is $\pm(\% \text{ reading} + \text{number of digits})$ at $23^{\circ}\text{C} \pm 5^{\circ}\text{C}$, less than 80% R.H.

DC / AC Volts

Function	Range	Accuracy
V \sim	1.3V ~ 750.0V	$\pm(1.5\% \text{ reading} + 3 \text{ digits})$ 50Hz ~ 500Hz
V $\overline{\sim}$	1.8V ~ 1000V	$\pm(1\% \text{ reading} + 2 \text{ digits})$
	-0.6V ~ -1000V	$\pm(1\% \text{ reading} + 4 \text{ digits})$

Overload protection: 750V_{rms} // 1000V_{DC}

Max. Operation time: DT=30s for $\geq 30\text{V}$

Input Impedance: $\geq 4\text{K}$ for input voltage up to 30V. Impedance increase with input voltage to 330K Ω at 1000V.

Resistance & Continuity

Function	Range	Accuracy
Ω \cdot)))	0.0 Ω ~ 99.9 Ω	$\pm(2\% \text{ reading} + 1\Omega)$
	100 Ω ~ 2000 Ω	$\pm(2\% \text{ reading} + 2 \text{ digits})$

Overload protection: 750V_{rms} // 1000V_{DC}

Max. Open Voltage: 1.5V

Continuity check: Internal sounds activates if the resistance of the circuit under test is less than 25 Ω . It will then turn off if the resistance is increased beyond 400 Ω .

Operating temperature: 0 $^{\circ}\text{C}$ ~ 40 $^{\circ}\text{C}$

AC Current

Function	Range	Accuracy
A \sim	0.6A ~ 200.0A	$\pm(1.8\% \text{ reading} + 3 \text{ digits})^*$ 50Hz ~ 60Hz

Overload protection: 400A

* $\pm(1.8\% \text{ reading} + 6 \text{ digits}) \leq 50\text{A}$

Physical and Environmental Characteristics

Characteristics	Description
Dimensions (WxHxL)	84mmx188mmx41mm
Weight (with battery)	230g
Environmental characteristics	Description
Temperature operating	0 to +50°C
Non-Operating	-20 to +60°C
Humidity (operating)	<80% R.H.
Altitude Operating	2,000M (6560 ft.)
Non-Operating	12,300M (40354 ft.)
Vibration & shock Operating	MIL-T-28800E TYPE II Class 5 2.66gRMS, 5 to 500 Hz, 3axes (10 minutes each)
Indoor Use	Indoor Use

Certifications and compliances

Safety	IEC 61010 and designed to meet UL 3111 specifications
Input rating	V / Ω : Category III 1000 Volts
Over voltage category	CAT III: Distribution level mains, fixed installation.
	CAT II: Local level mains, appliances, portable equipment
	CAT I: Signal level, special equipment or parts of equipment, telecommunication, electronics.
Pollution Degree 2	Do not operate in environments where conductive Pollutants may be present.
EC Declaration of Conformity	Meets the intent of Directive 89/336/EEC for Electromagnetic Compatibility and Low Voltage Directive 73/23/EEC for specifications as listed in the official Journal of the European Communities: En 55011 Class A: Radiated and Conducted Emissions. En 50082-1 Immunity: IEC 801-2 Electrostatic Discharge IEC 801-3 RF Radiated En 61010-1 Safety requirements for electrical equipment for measurement, control, and laboratory use.

Required Equipment

Required equipment is listed in Table B. If the recommended models are not available, equipment with equivalent specifications may be used.

Repairs or servicing should be performed only by qualified personnel.

Table B. Required Equipment

Equipment	Required Characteristics	Recommended Model
Calibrator	AC Voltage Range: 0 ~ 750V AC Accuracy: ±0.07% (Basic) Frequency Range: 40 ~ 1KHz Accuracy: ±2% DC Voltage Range: 0 ~ 1000V DC Accuracy: ±0.006% (Basic) Current Range: 0 ~ 10A Accuracy: AC (40Hz to 1KHz): ±0.08% (Basic) Resistance Range: 1Ω ~ 100MΩ Accuracy: ±0.03% (Basic)	1. Fluke 5700A Calibrator 2. 50 Turns Coil

Basic Maintenance

Warning

To avoid shock, remove the test leads and any input signals before opening the case or replacing the battery.

Opening the Meter Case

Caution

To avoid unintentional shock circuit, always place the uncovered Meter assembly on a protective surface. When the case of the Meter is open, circuit connections are exposed.

To open the Meter case, and do the following:

1. Disconnect test leads from any live source, push the button to OFF, and remove the test leads from the front terminals.
2. Remove the battery door by using a flat-blade screwdriver to turn the battery door screws turn counter-clockwise.
3. The case bottom is secured to the case top by two screws. Using a Phillips-head screwdriver, remove the two screws.

Replacing the Battery

The Meter powered by 9V battery for 61-096

To replace the battery refer to Figure.

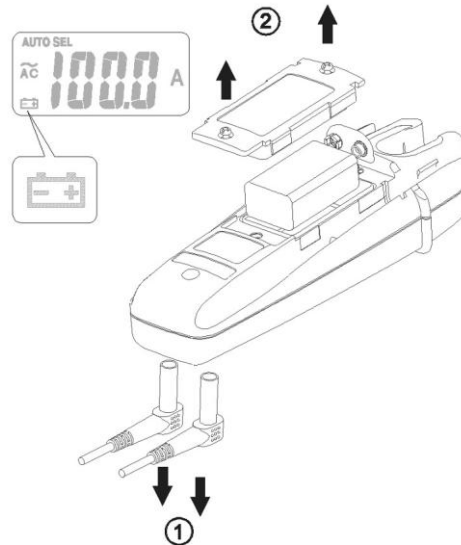

Performance Tests

The following performance tests verify the complete operability of the Meter and check the accuracy of each Meter function against the Meter's specifications.

Accuracy specifications are valid for a period of one year after calibration, when measured at an operating temperature of 18°C to 28°C and a maximum of 80% relative humidity.

To perform the following tests, it is not necessary to open the case, no Adjustments are necessary, merely make the required connections, apply the designated inputs, determine if the reading on the Meter display falls within the acceptable range indicated.

If the Meter fails any of these tests, it needs calibration adjustment or repair.

Testing the voltage Function

To verify accuracy in the AC and DC voltage ranges, do the following:

1. Push the button to start your meter.
2. Connect the Calibrator to the **VΩ** and **COM** inputs on the Meter.
3. Set the Calibrator for the voltage and frequency from step 1 to 8 in Table 1.
4. Compare the reading on the Meter display with the display reading shown in Table 1.
5. If the display reading falls outside of the range shown in Table 1, the Meter does not meet specification.

Table 1 AC Voltage Test:

Step	Input	Frequency	Reading
1	3.0V	50Hz	2.7 to 3.3
2	3.0V	500Hz	2.7 to 3.3
3	30.0V	50Hz	29.3 to 30.8
4	30.0V	500Hz	29.3 to 30.8
5	300.0V	50Hz	295.2 to 304.8
6	300.0V	500Hz	295.2 to 304.8
7	600.0V	50Hz	590.7 to 609.3
8	600.0V	500Hz	590.7 to 609.3

6. Set the calibration for the voltage from step 1 to 8 in Table 2.
7. Compare the reading on the Meter display with the display reading shown in Table 2.
8. If the display reading falls outside of the range shown in Table 2, the meter does not meet specification.

Table 2 DC Voltage Test:

Step	Input	Reading
1	3.0V	2.8 to 3.2
2	-3.0V	-2.6 to -3.4
3	30.0V	29.5 to 30.5
4	-30.0V	-29.3 to -30.7
5	600.0V	593.8 to 606.2
6	-600.0V	-593.6 to -606.4
7	900.0V	890.8 to 909.2
8	-900.0V	-890.6 to -909.4

Testing the Resistance Function

To verify the accuracy of the resistance function, do the following:

1. Connect the calibrator to **VΩ** and **COM** on the Meter.
2. Push the button to start your Meter.
3. Apply the inputs for step 1-6 in Table 3.
4. Compare the Meter display readings to the display readings in Table 3.
5. If the display reading falls outside of the range shown in Table 3, the Meter does not meet specification.

Table 3 Resistance Test:

Step	Source	Reading
1	50.0Ω	48.9 to 51.1
2	500Ω	488 to 512
3	800Ω	782 to 818
4	1200Ω	1174 to 1226
5	1500Ω	1468 to 1532
6	2000Ω	1958 to 2042

Continuity check: Internal sounds activates if the resistance of the circuit under test is less the 25Ω. It will then turn off if the resistance is increased beyond 400Ω

Testing the AC Current Function

To verify the accuracy of AC current measurement functions, do the following:

1. Open jaw of the meter around the suitable wire or conductor.
2. Push the button to start your meter.
3. Apply the inputs for steps 1-4 in Table 4.
4. For each input, compare the readings on the Meter display to the reading in Table 4.
5. If the display reading falls outside of the range shown in the Table 4, the meter does not meet specification.

Table 4 AC Current Test:

Step	Source	Frequency	Reading
1	100A	50Hz	97.9 to 102.1
2	100A	60Hz	97.9 to 102.1
3	200A	50Hz	196.1 to 203.9
4	200A	60Hz	196.1 to 203.9

CALIBRATION PROCEDURE

Recalibrate your meter:

It is recommended that the meter may be calibrated once year. Use the following procedure to calibrate the clamp meter.

1. Perform calibration at an ambient temperature and relative humidity ($23^{\circ}\text{C}\pm 2^{\circ}\text{C}$ and R.H. $\leq 80\%$). Allow instrument to sit at this temperature for at least thirty minutes.
2. Disconnect the test leads from any circuit under test and turn off meter.
3. Loosen the screws from the battery cover, remove battery cover and pull the battery out of battery box with battery still connected.
4. Loosen the two screws from the bottom case.
5. Lift the bottom case.

(A) DCV Calibration (Adjust VR15)

1. Press Hold button of the meter to power on.
2. Set the output of calibrator for DCV 100V and connect to V and COM test probes.
3. Using a small flat-tip screwdriver adjust the potentiometer VR15 until display reads 100.1V~100.2V.
4. Disconnect the output terminals of DCV calibrator.

(B) Resistance Calibration (Adjust VR13 & VR14)

1. Set the output of calibrator for resistance 1K Ω and connect to V and COM test probes.
2. Using a small flat-tip screwdriver adjust the potentiometer VR13 until display reads 1005 Ω ~1006 Ω .
3. Set the output of calibrator for resistance 100 Ω and connect to V and COM test probes.
4. Using a small flat-tip screwdriver adjust the potentiometer VR14 until buzzer sounds and check 400 Ω buzzer don't sounds.
5. Disconnect the output terminals of resistance calibrator.

(C) ACV Calibration (Adjust VR16& VR1)

1. Set the output of ACV calibrator for ACV 70V 60Hz and connect to V and COM test probes.
2. Using a small flat-tip screwdriver adjusts the potentiometer VR16 until display reads 70.0V ± 1 d.
3. Set the output of ACV calibrator for ACV 200V 60Hz and connect to V and COM test probes.
4. Using a small flat-tip screwdriver adjusts the potentiometer VR1 until display reads 199.8V ± 1 d.
5. Disconnect the ACV calibrator from the meter.

(D) ACA Calibration (Adjust VR17 & VR12)

1. Flow the current of ACA 100.0A 60Hz around the suitable wire or conductor.
2. Using a small flat-tip screwdriver adjusts the potentiometer VR17 until display reads 99.8A.
3. Flow the current of ACA 300.0A 60Hz around the suitable wire or conductor.
4. Position the clamp around the wire or conductor, release clamp trigger to make sure that the clamp is entirely closed.
5. Using a small flat-tip screwdriver adjusts the potentiometer VR12 until display reads 300.0A.
6. Remove the meter away from the wire or conductor.

A7A-1A SILKSCREEN BOT

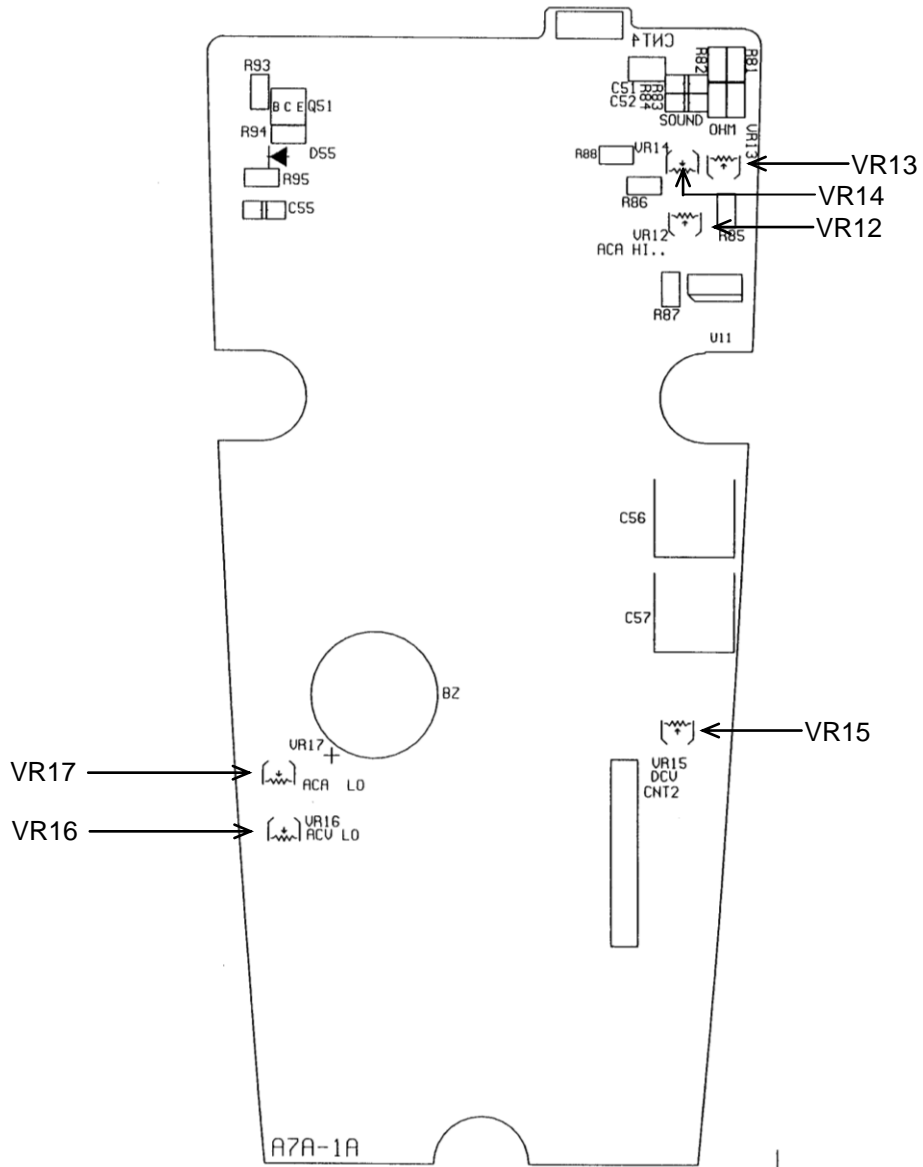

Figure 1

61-096
Calibration

Adjustment Points

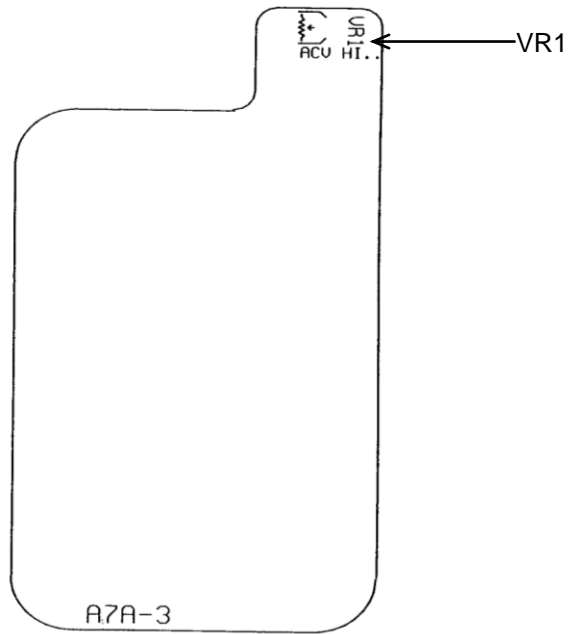

Figure 2 61-096 Calibration Adjustment Points