



Bender Guide



Features

Your IDEAL Bender has engineered features which include:

- 1. Arrow**
To be used with stub, offset and outer marks of saddle bends.
- 2. Rim Notch**
Locates the center of a saddle bend.
- 3. Star-Point**
Indicates the back of a 90° bend.
- 4. Degree Scale**
For offsets, saddles and those special situations.
- 5. A Choice**
High strength ductile iron or light weight aluminum.

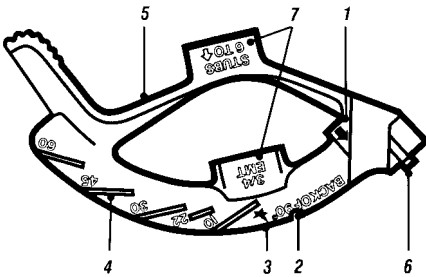

The above are features that lead to perfectly predictable and repeatable bends.

Instructions

Bend conduit with skill and professionalism. Take the guess-work out of bending.

Steps to Remember

- Step 1.** Measure your job.
- Step 2.** Mark you conduit using the recommended tables.
- Step 3.** Use your bender's engineered marks.

Note: Reference to the above Steps 1, 2, and 3 will be made throughout this booklet.

Don't Forget

- When bending on the floor, pin the conduit to the floor. Use heavy foot pressure.
- When bending in the air, exert pressure as close to your body as possible.
- In case you overbend, use the back pusher or the expanded end of the bender handle to straighten your conduit to fit the job.

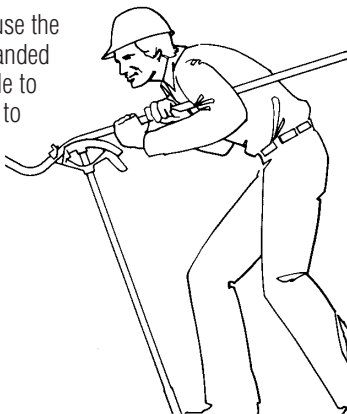

How to Bend a Stub

The stub is the most common bend. Note that your bender is marked with the “take-up” of the arc of the bender shoe.

Example:

Consider making a 14” stub, using a 3/4” EMT conduit.

- Step 1.** The IDEAL bender indicates stubs 6” to ↑. Simply *subtract* the take-up, or 6”, from the finished stub height. In this case 14” minus 6” = 8”.
- Step 2.** Mark the conduit 8” from the end.
- Step 3.** Line up the *Arrow* on the bender with the mark on the conduit and bend to 90°.

Remember: Heavy Foot pressure is critical to keep the EMT in the bender groove and to prevent kinked conduit.

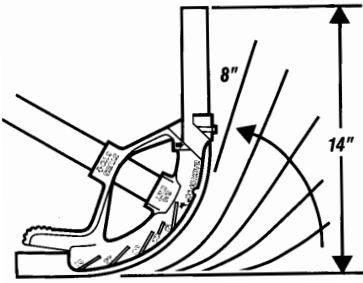

How to Make Back-To-Back Bends

A back-to-back bend produces a “U” shape in a single length of conduit. Use the same technique for a conduit run across the floor or ceiling which turns up or down a wall.

Example:

- Step 1.** After the first 90° bend has been made, measure to the point where the back of the second bend is to be, “B”.
- Step 2.** Measure and mark your conduit the same distance, mark “B”.
- Step 3.** Align the mark on the conduit with the Star-Point on the bender and bend to 90°.

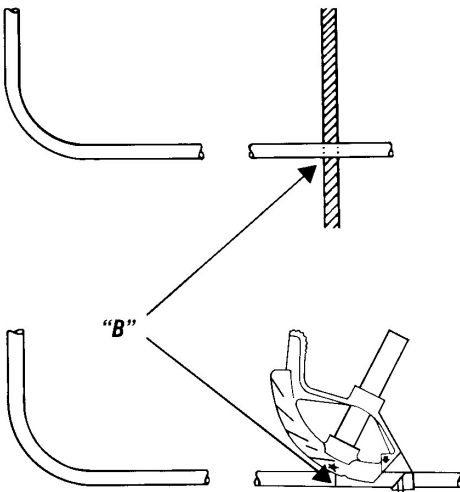

Star-Point on bender must be referenced for accurate bends.

How to make an Offset Bend

The offset bend is used when an obstruction requires a change in the conduit's plane.

Before making an offset bend, you must choose the most appropriate angles for the offset. Keep in mind that shallow bends make for easier wire pulling, steeper bends conserve space.

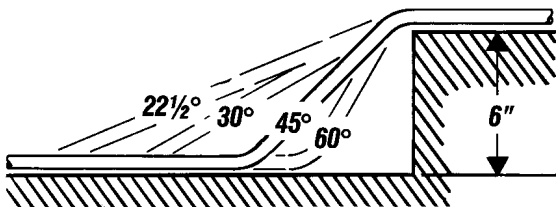

You must also consider that the conduit shrinks due to the detour. Remember to ignore the shrink when working away from the obstruction, but be sure to consider it when working into it.

Example:

- Step 1.** Measure the distance from the last coupling to the obstruction.
- Step 2.** Add the "shrink amount" from the table on page 5 to the measured distance and make your first mark. Your second mark will be placed at the "distance between bends." (Refer to table on page 5.)
- Step 3.** Align the *Arrow* with the first mark and using the *Degree Scale* bend to the chosen angle. Slide down the conduit and rotate conduit 180°, align the *Arrow* and bend as illustrated.



*Bend offsets in the air.
Remember to keep your body
pressure close to the bender.*

First Bend

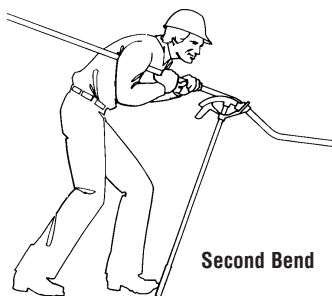

Example:

30° Bend with a 6" Offset Depth

Distance Between Bends ← $12''$ $1-1/2''$ → Shrink Amount

Reference Table for Offset Bends

Degree of Bend

	22-1/2°	30°	45°	60°					
2"	5-1/4"	3/8"							
3"	7-3/4"	9/16"	6"	3/4"					
4"	10-1/2"	3/4"	8"	1"					
5"	13"	15/16"	10"	1-1/4"	7"	1-7/8"			
6"	15-1/2"	1-1/8"	12"	1-1/2"	8-1/2"	2-1/4"	7-1/4"	3"	
7"	18-1/4"	1-5/16"	14"	1-3/4"	9-3/4"	2-5/8"	8-3/8"	3-1/2"	
8"	20-3/4"	1-1/2"	16"	2"	11-1/4"	3"	9-5/8"	4"	
9"	23-1/2"	1-3/4"	18"	2-1/4"	12-1/2"	3-3/8"	10-7/8"	4-1/2"	
10"	26"	1-7/8"	20"	2-1/2"	14"	3-3/4"	12"	5"	

How to Make Saddle Bends

The saddle bend is similar to an offset bend, but in this case the same plane is resumed. It is used most often when another pipe is encountered.

Most common is a 45° center bend and two 22-1/2° outer bends, but you can use a 60° center bend and two 30° bends.

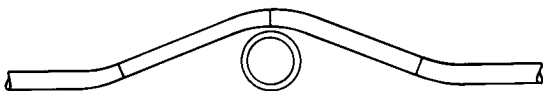

Important: Use the same calculation for either set of angles.

Example:

Step 1. You encounter a 3" O.D. pipe 4 feet from the last coupling. The formula shown in the chart below indicates that for each inch of outside diameter of the obstruction, you must move your center mark ahead $3/16"$ per inch of obstruction height and make your outer marks $2-1/2"$ per inch of obstruction height from the center mark.

Step 2. The following table gives the actual mark spacings. In this example, the center mark is moved ahead $9/16"$ to $48-9/16"$. The outer marks are $7-1/2"$ from the center mark, or $41-1/16"$ and $56-1/16"$. Mark your conduit at these points.

If Obstruction is	Move Your Center Mark Ahead	Make Outside Marks From Center Mark
1"	$3/16"$	$2-1/2"$
2"	$3/8"$	5"
3"	$9/16"$	$7-1/2"$
4"	$3/4"$	10"
5"	$15/16"$	$12-1/2"$
6"	$1-1/8"$	15"

Step 3.

(A) Align the center mark with the *Rim Notch* and bend to 45° .

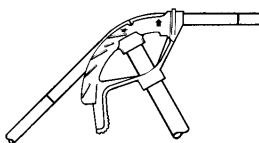

(B) Do not remove the conduit from the bender. Slide the bender down to the next mark and line up with the *Arrow*. Bend to $22-1/2^\circ$ as indicated.

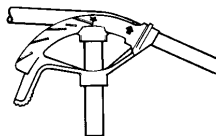

(C) Remove and reverse the conduit and locate the other remaining mark at the *Arrow*. Bend to $22-1/2^\circ$ as indicated.

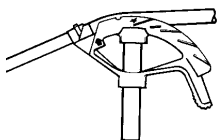

**CAUTION**

Be sure to line up all bends to be in the same plane.

Hickeys

Hickeys require a different approach to bending. It is not a fixed radius device but rather one that requires several movements per bend. The hickey can give you the advantage of producing bends with a very tight radius.

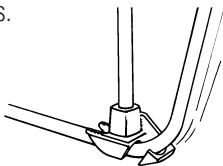

Order Information

Conduit Size	Ductile Iron Bender	Aluminum Bender	Hickey	Handle
EMT				
1/2"	74-001	74-031	74-010	74-019
3/4"	74-002	74-032	74-011	74-019
1"	74-003	74-033	74-012	74-020
1-1/4"	74-006	74-036	74-013	74-021
Rigid/IMC				
1/2"	74-002	74-032	74-011	74-019
3/4"	74-003	74-033	74-012	74-020
1"	74-006	74-036	74-013	74-021
Handles				
3/4" IPS 38" Long Expanded Extra High Strength Handle				74-019
1" IPS 44" Long Extra High Strength Handle				74-020
1-1/4" IPS 54" Long Extra High Strength Handle				74-021

The IDEAL bender line gives you the engineering design, indicator marks and durability to bend conduit with ease and confidence.

IDEAL INDUSTRIES, INC.

Sycamore, IL 60178, U.S.A.
800-435-0705 Customer Assistance
www.idealindustries.com

ND 1534-4