



Wire Connectors



For complete sales office contact information, visit us at:
www.idealind.com

IDEAL INDUSTRIES, INC.
1375 Park Avenue, Sycamore, IL 60178, USA / 815-895-5181 • 800-435-0705 in USA

International offices: Australia • Brazil • Canada • China • Germany • Mexico • UK
For complete sales office contact information, visit us at:

7/15
Form No. P-2873
Printed in USA
©2015 IDEAL INDUSTRIES, INC.



Wire Connectors

**BUILT FOR COMFORT.
DESIGNED FOR PERFORMANCE.**



Wire Connector Brochure

The Brand Electricians Trust.™

IDEAL Wire Connectors
are available in:



Box: For small jobs at hand, just grab a box.



Store 'N Pour™ Jar:
Easy-pour design keeps connectors clean
and your shelf organized.



Power Pouch™: The new IDEAL
Power Pouch™ connector bags are
convenient, re-closeable and stand
up on the job.



Barrel: For really big jobs
when you can't afford to run
out of connectors.

CONTENTS:

IDEAL and Buchanan Wire Connectors

Twister® PRO	2
Twister®	3
Twister® LT	3
Wing-Nut®	4
Wire-Nut®	5
B-CAP®	6
B-Twist™	7
WingTwist™	8
WireTwist™	9
WeatherProof™	10
UnderGround™	11
MudBug®	11
Twister® Al/Cu	12
PowerPlug®	13
SpiceLine®	14
In-Sure™ Push-In	15
Grounding	16
Application Guide	17
Ordering Guide	18-19
Wire Range Chart	20

You're a pro. You know to wire the job right you need the best wire connectors available. That's why day in and day out, you choose:

IDEAL. THE BRAND ELECTRICIANS TRUST.

IDEAL has a connector that's right for every job. Our complete line is built to provide safe, dependable solutions for every application.

Just pick the connector that's right for your job and right for you. You're the pro. You know what works best. IDEAL and Buchanan Wire Connectors. Built for performance and reliability.

For additional details on the entire line of IDEAL Wire Connectors or to request a full-line catalog, visit www.idealind.com



Wire Connectors



COMFORT
from the IDEAL family of
Performance & Reliability

For ultimate COMFORT and maximum wire range

When you've got a job where you'll be making connections all day, the Twister® PRO red/yellow wire connector is the one you want. The SureGrip™ design makes for improved torque while the comfortable swept wings ease hand fatigue. You'll feel the difference immediately.



Patented SureGrip™ overmolding provides improved leverage and more torque

Better grip and more leverage for faster connections

Exceptional wire range and capacity; up to MAX. 4 #10



Twister® PRO

FAST FACT:

The Twister® PRO is a high performance connector with the industry's widest wire range of any red/yellow connector.

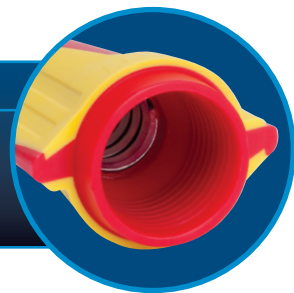

MIN. 2 #18
MAX. 4 #10



Cu/Cu Only



COMFORT
Twister® PRO
WIRE CONNECTORS

Twister® PRO Wire Connector:



600 Volts Max.*

*1,000 Volts signs and fixtures



More COMFORT, less fatigue

The Twister® Wire Connector easily handles the most common wiring configurations for residential construction projects. A patented, expanding square-wire spring ensures a quick, secure connection.



Hex-top allows for 5/16" nut driver application

Durable copolymer shell expands for progressive tightening, a feature that ensures dependable connections

Quick take-up on even the toughest combinations including solid-to-stranded

Swept-wing design for improved comfort and extra leverage

Twister®

FAST FACT:

The small profile of the Twister® LT makes it perfect for recessed lighting applications.

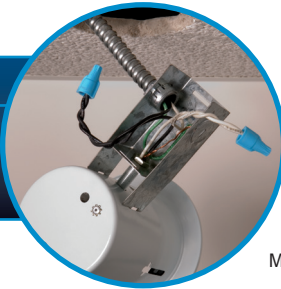

MIN. 3 #14
MAX. 2 #8 w/ 2 #12

MIN. 3 #22
MAX. 3 #10

MIN. 2 #22
MAX. 3 #12



Twister® Wire Connector:

600 Volts Max.*

340° Light Blue	MIN. 2 #22				MAX. 3 #12		
341° Tan		MIN. 3 #22				MAX. 3 #10	
342° Gray			MIN. 3 #14				MAX. 2 #8 w/ 2 #12

Wire Combinations: 2 #22 3 #22 3 #14 3 #12 3 #10 2 #8 w/ 2 #12

*1,000 Volts signs and fixtures

WIRE CONNECTORS
Twister®
COMFORT



More POWER with every twist

The Wing-Nut® Wire Connector provides an easy, secure grip when connecting a wide range of wires. The specially designed contoured wings make for extra torque and quick work on any electrical job.

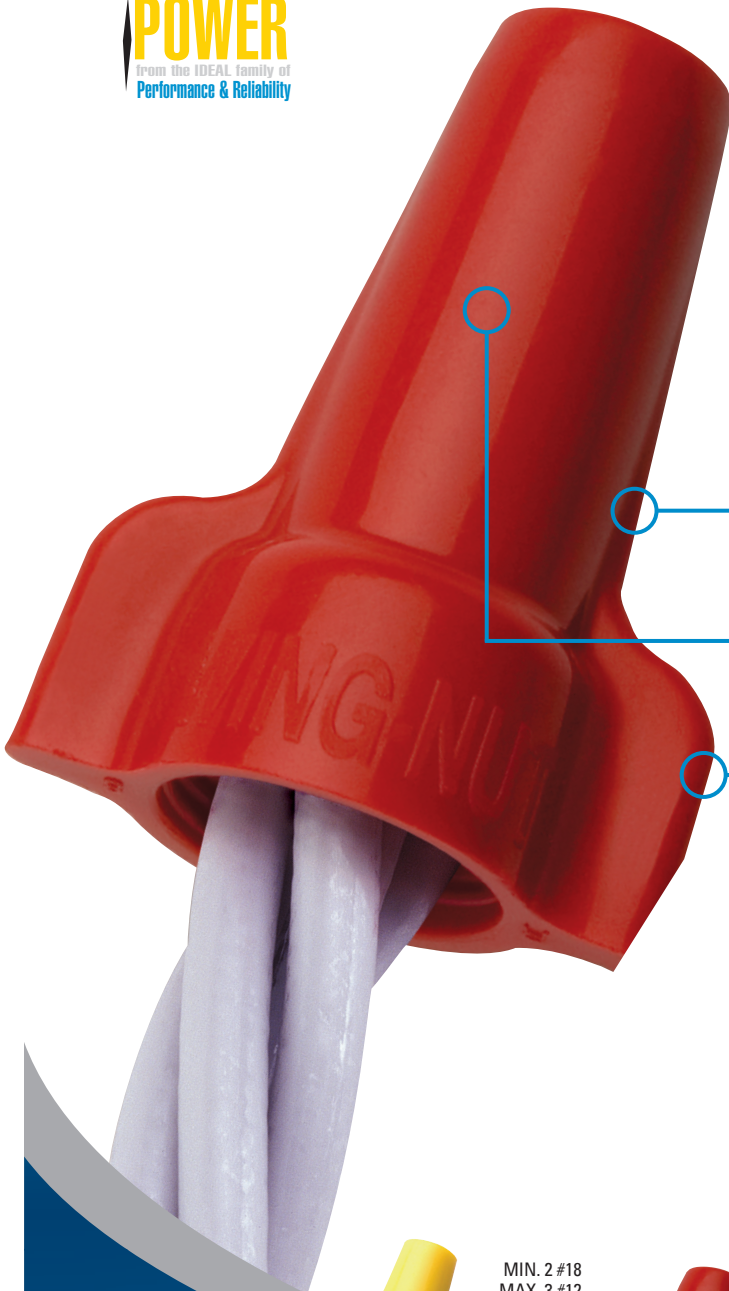

Copolymer shell expands for smooth, progressive tightening

Expanding, square-wire spring accommodates a wide range of wire sizes and combinations

Contoured wing profile provides extra leverage for maximum torque



Wing-Nut®

FAST FACT:

The red Wing-Nut® will accommodate up to 4 #10 wires – **WIDEST IN THE INDUSTRY!**



MIN. 2 #18
MAX. 3 #12



MIN. 2 #18
MAX. 4 #10



MIN. 3 #12
MAX. 1 #6 w/ 2 #8



Cu/Cu Only



POWER

Wing-Nut®

WIRE CONNECTORS

WingNut® Wire Connector:

600 Volts Max.*

451° Yellow	MIN. 2 #18	[Yellow bar]		MAX. 3 #12			
452° Red	MIN. 2 #18	[Red bar]				MAX. 4 #10	
454° Blue			MIN. 3 #12	[Blue bar]			MAX. 1 #6 w/ 2 #8

Wire Combinations: 2 #18 2 #14 3 #12 5 #12 4 #10 5 #10

*1,000 Volts signs and fixtures



The connector that started it all, an American CLASSIC

The original connector, for a full range of wires and jobs. With five color-coded models covering a range of wires from #22 to #6, the Wire-Nut® Wire Connector is the all-around twist-on you can count on.

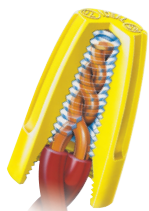

Positive-grip shell design

Square-wire fixed spring design creates its own threads for a grip that will last

Perfect for fine stranded wire applications

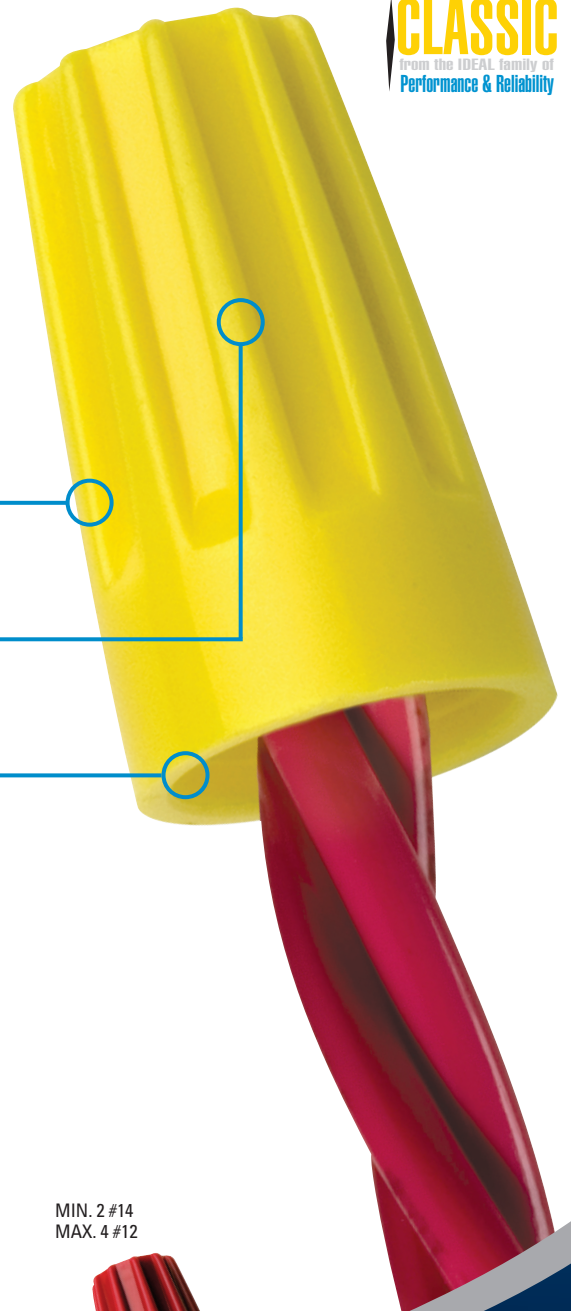

Wire-Nut®

FAST FACT:

Yellow and red Wire-Nut® connectors can easily be applied using the Twist-a-Nut™ Screwdriver.



WireNut® Wire Connector:

Wire Connector Color	Wire Size Range	Max. Voltage
71B® Gray (300V)**	MIN. 2 #22 Str. to MAX. 2 #16	300V
72B® Blue (300V)**	MIN. 2 #22 to MAX. 3 #16	300V
73B® Orange (600V)**	MIN. 1 #18 w/1 #20 to MAX. 2 #14	600V
74B® Yellow (600V)	MIN. 2 #18 to MAX. 4 #14 w/1 #18	600V
76B® Red (600V)	MIN. 2 #14 to MAX. 4 #12	600V



Wire Combinations: 2 #22 2 #20 2 #18 2 #14 3 #12 4 #12

600 Volts Max.*

CLASSIC

Wire-Nut®
WIRE CONNECTORS

COMPACT
from the IDEAL family of
Performance & Reliability

CONSTRUCTION PRODUCTS
BUCHANAN

COMPACT low profile design gets you into tight spaces

The B-CAP® Wire Connector gets you in those hard-to-reach spots comfortably, especially when you're retrofitting or updating. With an expanding interior spring, this connector accepts a wide range of wire sizes and combinations.

Comfortable, "Classic Fin™" design provides a secure grip for extra leverage

Unique, space-saving profile is perfect for "old work" or shallow boxes

The B2 "Universal Connector" easily handles two #18, up to five #12; will even dead-end a single #14

BCAP®

FAST FACT:

The B-CAP® is extremely popular with veteran electricians because of its wide range and space-saving design.

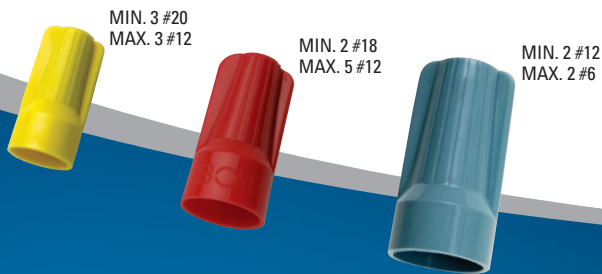

MIN. 3 #20
MAX. 3 #12

MIN. 2 #18
MAX. 5 #12

MIN. 2 #12
MAX. 2 #6



COMPACT

B-CAP®

WIRE CONNECTORS

B-CAP® Wire Connector:

B1 Yellow	MIN. 3 #20				MAX. 3 #12	
B2 Red		MIN. 2 #18			MAX. 5 #12	
B4 Blue			MIN. 2 #12			MAX. 2 #6

Wire Combinations: 3 #20 2 #18 2 #12 3 #12 5 #12 2 #6



600 Volts Max.*

*1,000 Volts signs and fixtures



The connector for SPEED

The B-Twist™ Wire Connector combines all the features of red and yellow wire connectors in one unique design that comes to torque quick and easy. The rounded “dial-top” provides fast, fingertip starts and its low-profile design fits easily into electrical boxes. With a wide wire range, the B-Twist provides top performance at a great value.

Vertical ribs improve grip

Long swept-wings improve comfort and torque

Deep skirt helps protect over-stripped wires

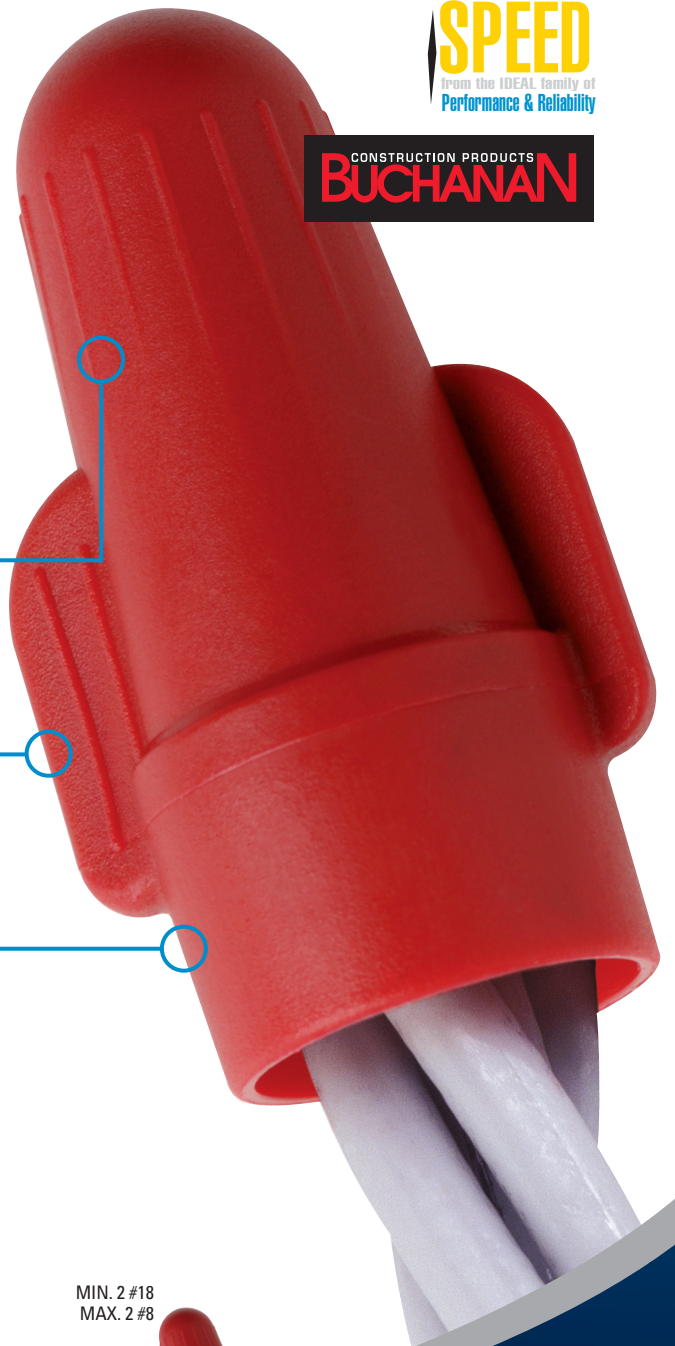

FAST FACT:

The B-Twist™ handles the entire range of a red and yellow connector

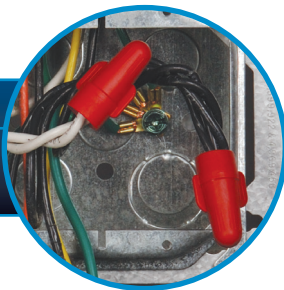

MIN. 2 #18
MAX. 2 #8



Cu/Cu Only



B-Twist™ Wire Connector:



Wire Combinations: 2 #18 2 #14 3 #12 3 #10 5 #12 2 #8

*1,000 Volts signs and fixtures

SPEED
B-Twist™
 WIRE CONNECTORS

Great combination of performance and value

The contoured wing design of the WingTwist™ Wire Connector provides maximum torque for a variety of electrical applications.

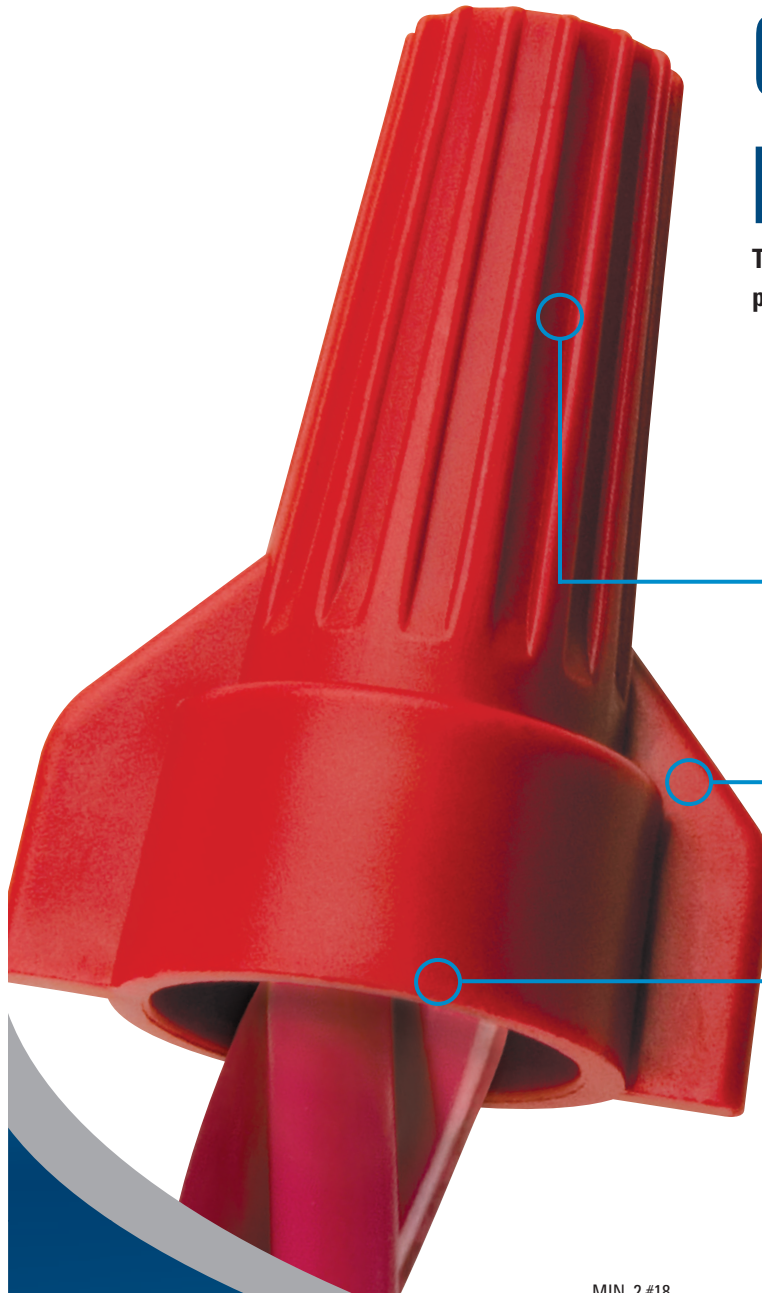

Ribs expand for progressive tightening

Contoured wing design improves leverage

Wide deep skirt opening accommodates a variety of wire combinations

Wing-Twist™

FAST FACT:

A full line for virtually every wire size and combination.

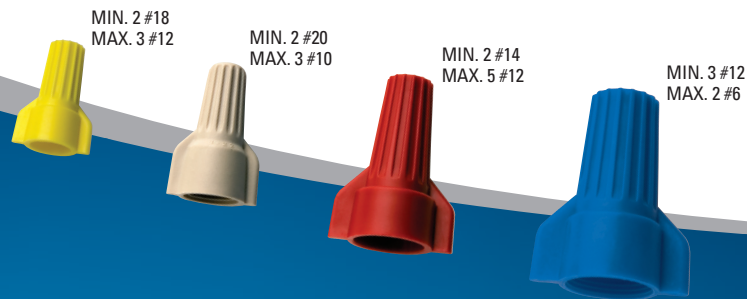

MIN. 2 #18
MAX. 3 #12

MIN. 2 #20
MAX. 3 #10

MIN. 2 #14
MAX. 5 #12

MIN. 3 #12
MAX. 2 #6

WingTwist™
WIRE CONNECTORS

WingTwist™ Wire Connector:

WT51 Yellow		MIN. 2 #18		MAX. 3 #12		
WT41 Tan	MIN. 2 #20				MAX. 3 #10	
WT52 Red			MIN. 2 #14		MAX. 5 #12	
WT54 Blue				MIN. 3 #12		MAX. 2 #6

Wire Combinations: 2 #20 2 #18 2 #14 3 #12 5 #12 2 #6

UL LISTED Wire Connector 774A
Cu/Cu Only
LR9706
600 Volts Max.*

*1,000 Volts signs and fixtures

Exceptional value at every turn

The price is right for this economical connector that brings you a lot of value in comfort and performance.

Positive grip shell design

Flame-retardant shell rated at 105 °C (221 °F)

Multiple sizes accommodate a broad range of electrical applications

Wire-Twist™

FAST FACT:

Developed for projects on tight budgets.



Cu/Cu Only



WireTwist™ Wire Connector:

600 Volts Max.*

WT1 Gray (300V)	MIN. 3 #22				MAX. 2 #16			
WT2 Blue (300V)		MIN. 3 #20			MAX. 3 #16			
WT3 Orange (600V)			MIN. 2 #18			MAX. 2 #14		
WT4 Yellow (600V)			MIN. 2 #18				MAX. 2 #12	
WT6 Red (600V)					MIN. 2 #14			MAX. 4 #12
Wire Combinations:	3 #22	3 #20	2 #18	2 #16	2 #14	2 #12	4 #12	

*1,000 Volts signs and fixtures

WireTwist™
WIRE CONNECTORS

Connected and protected

Designed specifically for above grade, interior/ exterior connections exposed to damp/wet and corrosive environments. WeatherProof™ Wire Connectors are pre-filled with a non-hardening, silicone-based sealant that protects against moisture and corrosion.



Easy to apply, pre-filled twist-on wire connectors

Swept wing design is built for comfort and efficiency

UL Listed to 486D for use in damp or wet above-grade locations

WeatherProof™

FAST FACT:

The silicone-based sealant protects electrical connections against harsh conditions, eliminating the need for heat-shrink or excessive taping.

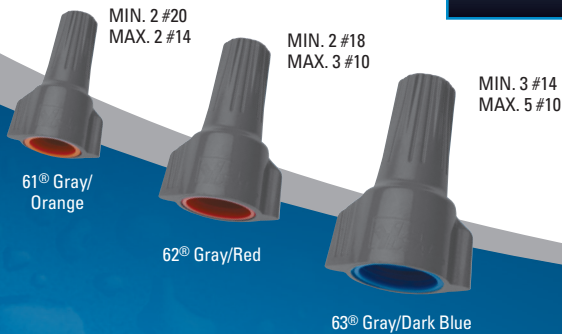
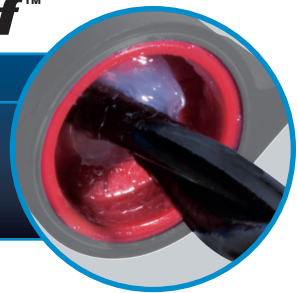

WeatherProof™
WIRE CONNECTORS



600 Volts Max.*

WeatherProof™ Wire Connector:

61® Gray/Orange	MIN. 2 #20	MAX. 2 #14						
62® Gray/Red		MIN. 2 #16	MAX. 2 #10					
63® Gray/Dark Blue			MIN. 3 #14	MAX. 5 #10				

Wire Combinations: 2 #20 2 #16 2 #14 3 #14 3 #12 2 #10 5 #12 5 #10

*1,000 Volts signs and fixtures

The connector made specifically for harsh underground environments

UnderGround™ Wire Connectors are designed to secure and protect connections in a wide variety of below-grade wet location and direct burial applications. Quick and easy application saves time and energy, eliminating the need for heat shrink, resin-packs, and multi-step corrosion kits.

Expanding, live-action square-wire spring for fast, secure, and long lasting connections

UL listed to 486D for use in damp/wet or direct burial/below-grade applications

Deep skirt provides superior moisture resistance to protect electrical connections

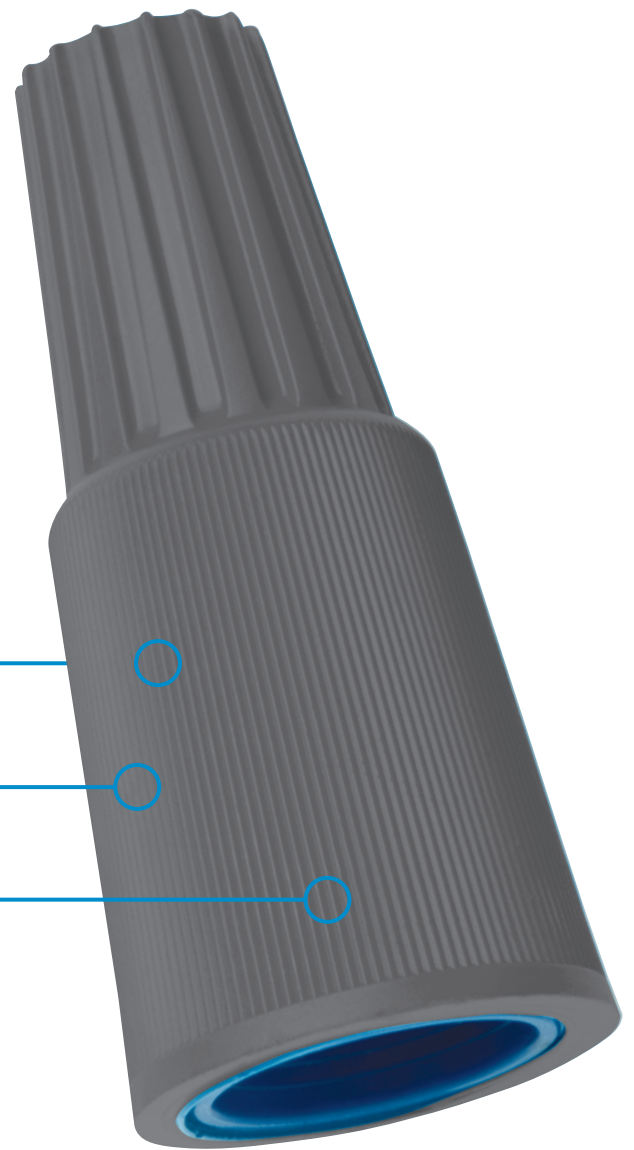

UnderGround™

FAST FACT:

Tough, thermoplastic shell provides extra protection against accidental impacts.



Perfect for utility tracer line applications.

MIN. 1 #20 w/1 #18
MAX. 1 #10 w/2 #12

MIN. 2 #18
MAX. 3 #10

MIN. 1 #20 w/1 #18
MAX. 1 #10 w/2 #12

MIN. 2 #18 Sol.
MAX. 3 #10

MIN. 3 #12
MAX. 2 #6 w/1 #10



60° Yellow



64° Yellow



60° Gray/Blue

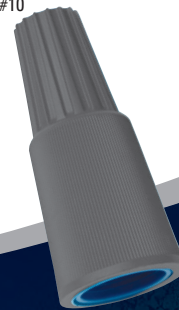

64° Gray/Dark Blue

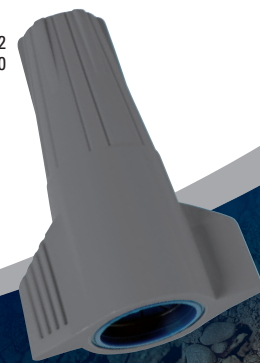

66° Gray/Dark Blue



Cu/Cu Only



UnderGround™/MudBug® Wire Connector:

60° Gray/Blue	MIN. 1 #20 w/1 #18					MAX. 1 #10 w/2 #12		
64° Gray/Dark Blue		MIN. 2 #18 Sol.					MAX. 3 #10	
66° Gray/Dark Blue				MIN. 3 #12				MAX. 2 #6 w/1 #10
60° Yellow	MIN. 1 #20 w/1 #18					MAX. 1 #10 w/2 #12		
64° Yellow		MIN. 2 #18 Sol.					MAX. 3 #10	

Wire Combinations:

2 #20 2 #18 2 #16 2 #14 3 #12 3 #10 5 #10

*1,000 Volts signs and fixtures

UnderGround™
WIRE CONNECTORS

The only twist-on for aluminum to copper connections

The Twister® Al/Cu Wire Connector is the only UL listed aluminum-to-copper twist-on connector that prevents aluminum oxidation while providing a secure connection. Anti-oxidant compound cuts through oxidation on aluminum conductors for improved conductivity and cooler connections.



Patented swept-wing design for comfortable connections

Pre-filled antioxidant compound prevents oxidation of aluminum conductors

Entry cap retains corrosion-resistant compound

Twister® Al/Cu

FAST FACT:

Aluminum wiring was common in 1970's era construction. The Twister® Al/Cu provides a solution for improved connections with today's copper wiring.



Twister® Al/Cu
WIRE CONNECTORS

Twister® Al/Cu Wire Combinations:

600 Volts Max.

1 #10 Al solid w/1 or 2 #10 Cu solid	1 #12 Al w/1 or 2 #14 Cu
1 #10 Al w/1 or 2 #12 Cu	2 #12 Al solid w/1 #14 Cu
2 #10 Al solid w/1 #12 Cu	1 #10 Al w/1 or 2 #18 Cu
1 #10 Al w/1 or 2 #14 Cu	2 #10 Al solid w/1 #18 Cu
2 #10 Al solid w/1 #14 Cu	1 #12 Al w/1 or 2 #16 Cu
2 #12 Al solid w/1 #10 Cu	2 #12 Al solid w/1 #16 Cu
1 #12 Al solid w/1 or 2 #10 Cu	1 #10 Al w/1 or 2 #16 Cu
1 #12 Al stranded w/1 or 2 #10 Cu solid	2 #10 Al solid w/1 #16 Cu
1 #12 Al w/1 or 2 #12 Cu	1 #12 Al w/1 or 2 #18 Cu
2 #12 Al solid w/1 #12 Cu	2 #12 Al solid w/1 #18 Cu

WARNING:

1. One time use only. Do not reuse connector.
2. Do not use on aluminum to aluminum wire combinations.
3. Wiring must comply with all applicable electrical codes.
4. Contact IDEAL for complete wire combination listing.



Cu/Cu Only



Fast, safe, efficient ballast installation

The IDEAL PowerPlug® Luminaire Disconnect is perfect for new lighting installations and retrofit lighting applications. It's the first push-in luminaire disconnect that fully meets the National Electrical Code for non-residential fluorescent fixtures with ballasts. [2005 NEC 410.73(G), 2008 and 2011 NEC 410.130(G)]

Patented IDEAL push-in technology quickly locks wires in place

Both halves are "touch-safe" per UL 2459

Fits through 1/2" knockout

powerplug®

Luminaire Disconnect

FAST FACT:

The PowerPlug® allows safe disconnect of hot and neutral ballast wiring.

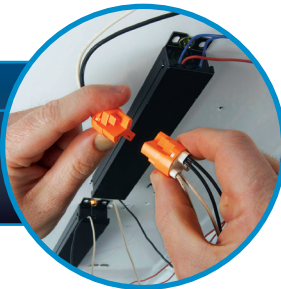

PowerPlug® 102: 6 Amps/600 Volts Max.

Wire Range	Line Side/Ballast Side
Solid	#12 - #18
Stranded	#12 - #14 (19 strand or less)
Stranded	#12 - #14 (19 strand or less)
Tin-Bonded	#16 (26 strand or less)
	#18 (16 strand or less)

PowerPlug® 103: 6 Amps/600 Volts Max.

Wire Range	Line Side	Ballast Side
Solid	#12 - #18	#18
Stranded	#12 - #14 (19 strand or less)	None
Stranded	#12 - #14 (19 strand or less)	#18 (16 strand or less)
Tin-Bonded	#16 (26 strand or less)	
	#18 (16 strand or less)	

PowerPlug® 182/183: 3 Amps/120 Volts Max.

Wire Range	Line Side/Ballast Side
Solid	#18

PowerPlug®
LUMINAIRE DISCONNECT

A faster alternative to the butt-splice

The SpliceLine® In-Line Wire Connector provides a crimp-free, solderless butt-splice. The two-port model supports a wide range of wires, allowing one connector to do the job of three butt-splices. Its end-to-end connection is also a great solution for pre-fab operations.

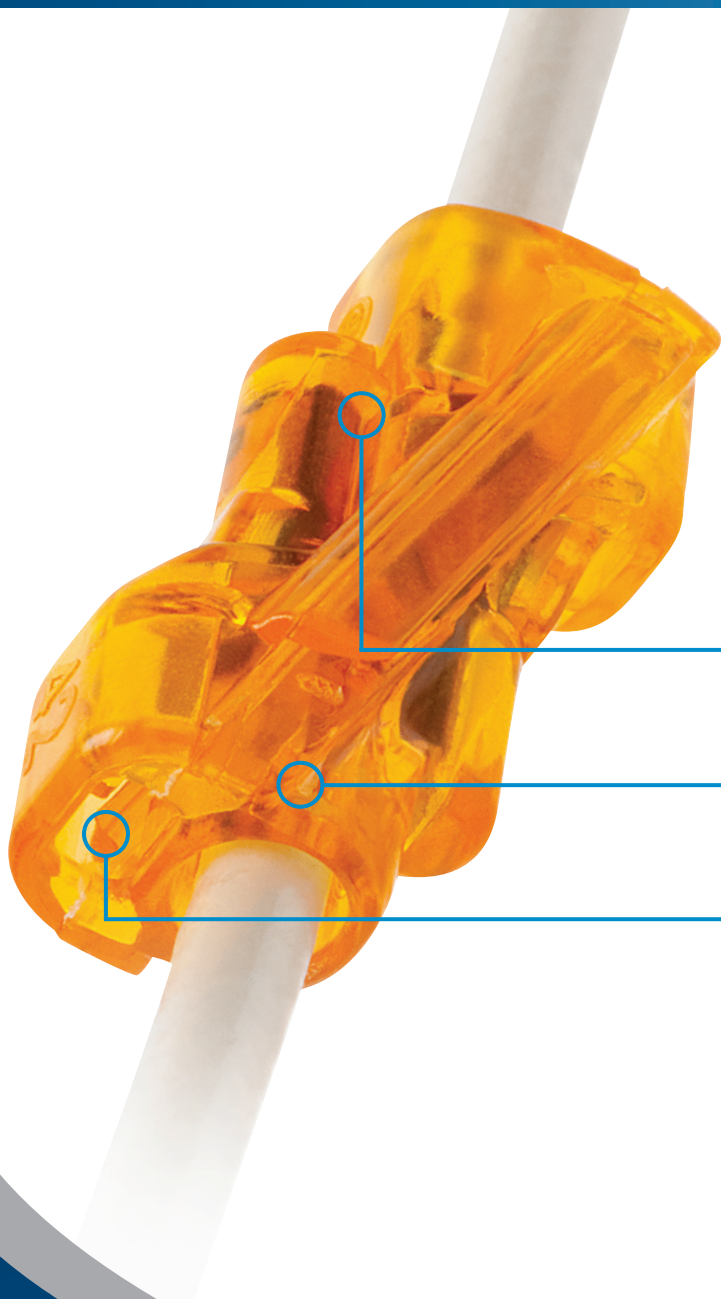

Transparent polycarbonate shell allows for visual inspection of connection

Slim design fits through 1/2" knockout

Check port for continuity testing

SpliceLine® IN-LINE WIRE CONNECTORS

FAST FACT:

Perfect for lengthening short wires, the SpliceLine® is 2X faster than traditional butt-splices.



42
2-Port



SpliceLine®
WIRE CONNECTORS

SpliceLine® Model 42: 600 Volts Max.

Solid	#20 – #12 solid
Stranded	#16 – #12 (19 strand or less)
Stranded Tin-Bonded	#18 – #14 (19 strand or less)

For use on insulation types TFN, TFFN, THHN, XHHW, T90 nylon or equivalent.



Cu/Cu Only



Strip, Push, Connect- The fastest way to make a connection

The In-Sure™ Push-In wire connector is perfect for residential, light commercial, lighting retrofit and pre-fab wiring systems. The fastest, easiest, no-twist push-in connector on the market.

Clear shell allows visual inspection of the connection

No-twist push-in design reduces repetitive motion fatigue

Full line accommodates #20 – #12, 2 to 4 wire connections

In-Sure™

FAST FACT:

The In-Sure™ Push-In has low insertion force for fast, easy connections. Great for pre-fab wiring.

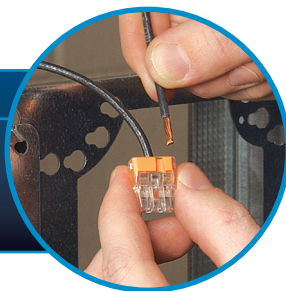

Cu/Cu Only



32
2-Port



33
3-Port

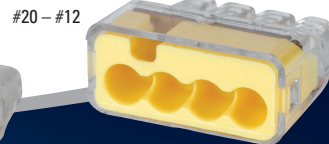

34
4-Port



39
3-Port

ACCEPTS
#10 AWG

In-Sure™ Models 32, 33, 34:

600 Volts Max.

Solid	#20 – #12 solid
Stranded	#16 – #12 (19 strand or less) #18 (7 strand)
Stranded Tin-Bonded	#18 – #14 (19 strand or less)

In-Sure™ Model 39:

600 Volts Max.

Solid	#14 – #10 solid
Stranded	#12 – #10 (19 strand or less)
Stranded Tin-Bonded	#14 – #10 (19 strand or less)

In-Sure™ Push-In
WIRE CONNECTORS

We've got grounding covered

Grounding Pigtails are designed for a wide variety of grounding applications. The ultra-flexible lead wire and bonding jumpers make for fast and efficient pigtailing.

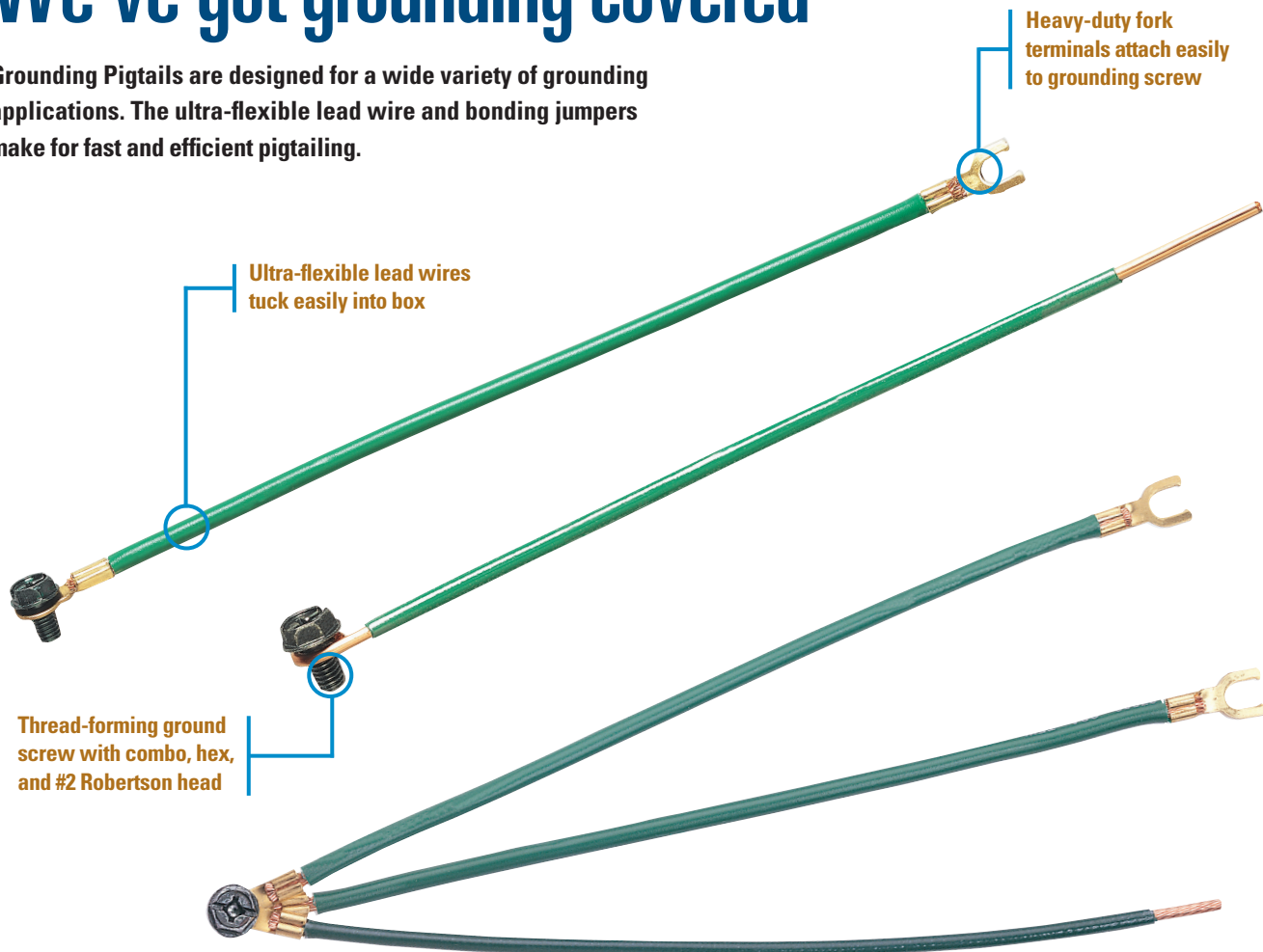

Ensures compliance with NEC standards

MIN. 2 #14
MAX. 3 #12 w/1 #14

MIN. 2 #14
MAX. 5 #12

MIN. 2 #14
MAX. 5 #12



Grounding

Greenie®, Green-B® & WGR Grounding Connectors

Designed for making ground connections and bonding non-metallic sheathed cable

UL Listed and CSA Certified; fully meets the intent of NEC sections 250.146 and 250.148

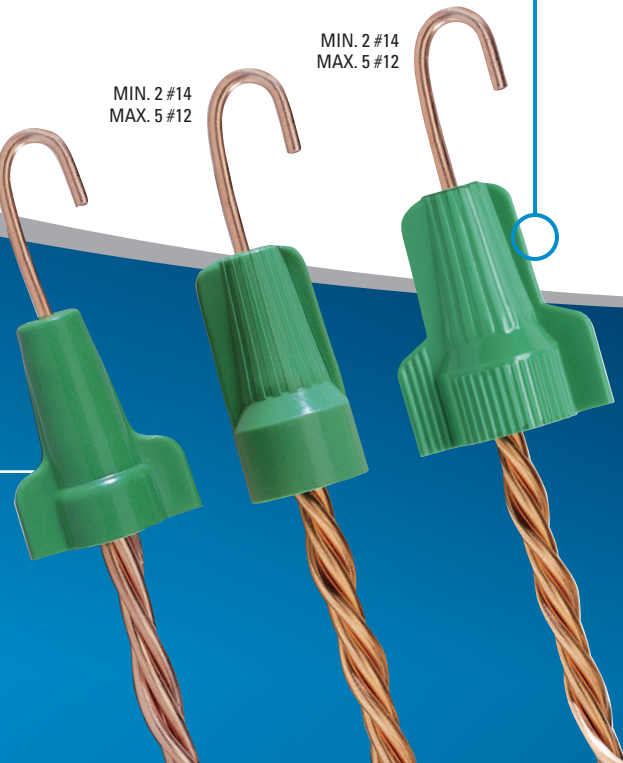

Cu/Cu Only





Application Guide

Model:	RESIDENTIAL								COMMERCIAL									
	Light Switches	Receptacles	Ceiling Fans	Can Lights	Thermostat Controls	HVAC	Smoke/CO2 Detectors	Garage Door Opener	Door Bells	Multi-Gang Switch Boxes	Security Systems	Intercoms	Recessed Lighting	Controls	Illuminated Signage	Receptacles	3-Phase Motors	HVAC
Twister®																		
340® Lt. Blue	●		●	●			●		●		●							
341® Tan	●	●					●	●	●									●
344® Red/Yellow	●	●					●		●				●	●	●	●	●	●
342® Gray	●												●	●			●	●
Wire-Nut®																		
71B® Gray	●					●				●	●							
72B® Blue	●					●	●			●	●							●
73B® Orange	●		●	●					●	●	●							●
74B® Yellow	●		●	●					●			●	●					
76B® Red	●	●					●					●	●	●	●	●	●	●
Wing-Nut®																		
451® Yellow	●	●	●	●				●			●							●
452® Red	●	●					●		●				●	●	●	●	●	●
454® Blue	●											●	●		●	●		●
B-CAP®																		
B1 Yellow	●		●	●				●			●							●
B2 Red	●	●					●		●				●	●	●	●	●	●
B4 Blue	●											●	●		●	●		●
B-Twist™																		
BT2™ Red	●	●					●		●				●	●	●	●	●	●
WingTwist™																		
WT51 Yellow	●		●	●				●			●							●
WT41 Tan	●	●					●	●	●				●	●				●
WT52 Red	●	●					●		●				●	●	●	●	●	●
WT54 Blue	●											●	●		●	●		●
WireTwist™																		
WT1 Gray	●					●				●	●							
WT2 Blue	●					●	●			●	●							●
WT3 Orange	●		●	●					●	●	●							●
WT4 Yellow	●		●	●					●			●	●					●
WT6 Red	●	●					●		●				●	●	●	●	●	●



Model:	RESIDENTIAL								COMMERCIAL									
	Landscape Lighting	Pool Filters/Controls	Outdoor Power Outlets	Patio/Deck Lighting	Bathroom/Spa Vent Fans	Security Systems	Basement/Garage	Lawn-Sprinkler Controls	Sump/Well Pumps	Landscape Lighting	Security Systems	Exterior Lighting	Street/Parking Lot Lighting	Car Washes	Processing Plants	Traffic Signals	Ejection Pumps	HVAC
WeatherProof™																		
61® Gray/Orange					●	●		●		●			●	●	●			●
62® Gray/Red		●	●	●				●			●		●	●				●
63® Gray/Dark Blue		●	●	●				●			●		●	●				●
UnderGround™																		
60® Gray/Blue	●			●	●			●		●	●				●	●		●
64® Gray/Dark Blue	●			●				●		●					●	●		●
66® Gray/Dark Blue											●				●			●

Ordering Guide





Twister® Wire Connectors

Model	Quantity	Cat. No.
 340° Lt. Blue	Box of 100	30-340
	Jar of 500	30-640J
	Barrel of 35,000	30-840
 341° Tan	Box of 100	30-341
	Jar of 400	30-441J
	Bag of 500	30-641
	Jar of 750	30-341J
	Carton of 1,000	30-541
 342° Gray	Barrel of 25,000	30-841
	Box of 50	30-342
	Bag of 250	30-642
 344° Red/Yellow	Barrel of 15,000	30-842
	Box of 50	30-144
	Jar of 250	30-244J
	Jar of 500	30-644J
	Barrel of 20,000	30-944

Wing-Nut® Wire Connectors



Model	Quantity	Cat. No.
 451° Yellow	Box of 100	30-451
	Jar of 225	30-451J
	Jar of 500	30-651J
	Bag of 250	30-651
	Barrel of 35,000	30-851
 452° Red	Box of 100	30-452
	Jar of 300	30-452J
	Jar of 500	30-652J
	Bag of 500	30-652
 454° Blue	Barrel of 25,000	30-852
	Box of 25	30-454
	Bag of 500	30-654
	Carton of 250	30-554

Wire-Nut® Wire Connectors

Model	Quantity	Cat. No.
 71B° Gray	Box of 100	30-071
	Keg of 25,000	30-271
	Barrel of 150,000	30-871
 72B° Blue	Box of 100	30-072
	Keg of 10,000	30-272
	Barrel of 85,000	30-872
 73B° Orange	Box of 100	30-073
	Jar of 300	30-073J
	Bag of 500	30-273
	Barrel of 50,000	30-873
 74B° Yellow	Box of 100	30-074
	Jar of 175	30-074J
	Bag of 500	30-274
	Barrel of 35,000	30-874
 76B° Red	Box of 100	30-076
	Bag of 250	30-276
	Barrel of 15,000	30-876

Other package configurations available.
Please contact IDEAL or your local
IDEAL distributor for more information.

B-CAP® Wire Connectors

Model	Quantity	Cat. No.
 B1 Yellow	Box of 100	B1-1
	Jar of 250	B1-250JR
	Jar of 500	B1-500JR
	Bag of 500	B1-B
	Barrel of 25,000	B1-SK
 B2 Red	Box of 100	B2-1
	Jar of 350	B2-350JR
	Jar of 500	B2-500JR
	Bag of 500	B2-B
	Barrel of 25,000	B2-SK
 B4 Blue	Box of 25	B4-1
	Carton of 250	B4-B





B-Twist™ Wire Connectors

Model	Quantity	Cat. No.
 BT2™ Red	Box of 100	BT2-1
	Jar of 500	BT2-500JR
	Barrel of 25,000	BT2-SK



WingTwist™ Wire Connectors

Model	Quantity	Cat. No.
 WT51 Yellow	Box of 100	WT51-1
	Bag of 500	WT51-B
	Jar of 500	WT51-500JR
	Barrel of 25,000	WT51-SK
 WT41 Tan	Box of 100	WT41-1
	Bag of 500	WT41-B
	Jar of 500	WT41-500JR
	Barrel of 25,000	WT41-SK
 WT52 Red	Box of 100	WT52-1
	Bag of 500	WT52-B
	Jar of 500	WT52-500JR
	Barrel of 25,000	WT52-SK
 WT54 Blue	Box of 50	WT54-1
	Bag of 100	WT54-B



WireTwist™ Wire Connectors

Model	Quantity	Cat. No.
 WT1 Gray	Box of 100	WT1-1
	Bag of 500	WT1-B
 WT2 Blue	Box of 100	WT2-1
	Bag of 500	WT2-B
	Keg of 50,000	WT2-SK
 WT3 Orange	Box of 100	WT3-1
	Bag of 500	WT3-B
	Barrel of 50,000	WT3-SK
 WT4 Yellow	Box of 100	WT4-1
	Bag of 500	WT4-B
	Barrel of 25,000	WT4-SK
 WT6 Red	Box of 100	WT6-1
	Bag of 250	WT6-B
	Barrel of 25,000	WT6-SK



WeatherProof® Wire Connectors

Model	Quantity	Cat. No.
61®/62®	Asst., Card of 10	30-6162
 61® Gray/Orange	Card of 25	30-1161
	Jar of 150	30-1261J
	Box of 1,000	30-1361
	Card of 20	30-1162
 62® Gray/Red	Jar of 100	30-1262J
	Box of 1,000	30-1362
	Card of 15	30-1163
 63® Gray/Dk. Blue	Jar of 50	30-1263J
	Box of 1,000	30-363

UnderGround® Wire Connectors

Model	Quantity	Cat. No.
60®/64®	Asst., Card of 10	30-6064
 60® Gray/Dk. Blue	Card of 25	30-1160
	Carton of 100	30-1260
	Carton of 1,000	30-1630
 64® Gray/Dk. Blue	Carton of 50	30-1264
	Box of 1,000	30-1364
 66® Gray/Dk. Blue	Box of 50	30-1066





MudBug® Utility Wire Connectors

Model	Quantity	Cat. No.
 60® Yellow	Box of 25	30-160Y
	Box of 1,000	30-360Y
 64® Yellow	Box of 25	30-164Y

Twister® Al/Cu Wire Connectors

Model	Quantity	Cat. No.
 65 Purple	Card of 2	30-065
	Card of 10	30-765
	Card of 25	30-165
	Box of 100	30-265
	Carton of 1,000	30-365

PowerPlug® Luminaire Disconnects





Model	Quantity	Cat. No.
 102 2-Pole	Card of 25	30-372
	Jar of 75	30-382J
	Jar of 150	30-352J
	Carton of 1,000	30-102
	Card of 20	30-383X
 103 3-Pole	Jar of 50	30-383XJ
	Jar of 100	30-353XJ
	Carton of 1,000	30-103X
	Box of 100	30-082
 182 2-Pole	Carton of 2,500	30-682
	w/6" leads, Carton of 1,000	30-682L*
 183 3-Pole	Box of 100	30-083
	Carton of 2,500	30-683

*8 -10 week lead time.







SpliceLine™ Wire Connectors

Model	Quantity	Cat. No.
 42 Orange	Bag of 10	30-1342S
	Box of 100	30-1042
	Jar of 300	30-1042J
	Box of 2,500	30-1642

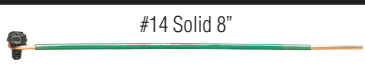
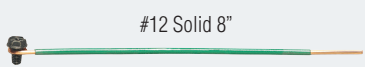



In-Sure™ Push-In Wire Connectors

Model	Ports	Quantity	Cat. No.
 32 Red	2	Box of 100	30-1032
		Jar of 300	30-1032J
		Box of 5,000	30-1632
 33 Orange	3	Box of 100	30-1033
		Jar of 250	30-1033J
		Box of 5,000	30-1633
 34 Yellow	4	Box of 100	30-1034
		Jar of 200	30-1034J
		Box of 5,000	30-1634
 39 Blue (#14-#10)	3	Box of 50	30-1039
		Jar of 150	30-1039J
		Box of 2,500	30-1639

Grounding Products

Model	Quantity	Cat. No.
 #14 Solid 8"	Box of 50	30-3390
	Box of 50	30-3392
	Box of 100	30-3399
 #12 Solid 8"	Box of 100	30-3399
	Box of 1,000	30-3496
 #14 Stranded 7-3/4"	Bag of 25	30-3183
	Bag of 25	30-3184
 #12 Stranded 7-3/4"	Box of 50	30-3385
	Box of 1,000	30-3284
	Box of 500	30-3286
 30-3287	Bag of 25	30-3287
 30-3288	Bag of 25	30-3288
 30-3289	Bag of 25	30-3289

Other tail lengths, wire gauges, combinations and package configurations available.

Model	Quantity	Cat. No.
 92® Greenie®	Box of 100	30-092
	Jar of 150	30-092J
	Bag of 500	30-292
	Box of 1,000	30-192
 BGR Green-B®	Box of 50	BGR-1
	Keg of 2,500 (10 bags, 250 ea.)	BGR-B
 WGR Green	Box of 50	WGR-1
	Jar of 500	WGR-500JR
	Keg of 5,000 (20 bags, 250 ea.)	WGR-B
Model	Quantity	Cat. No.
 Ground Screw	Pack of 50	30-3194
	Jar of 100	30-3594

Wire Range Chart

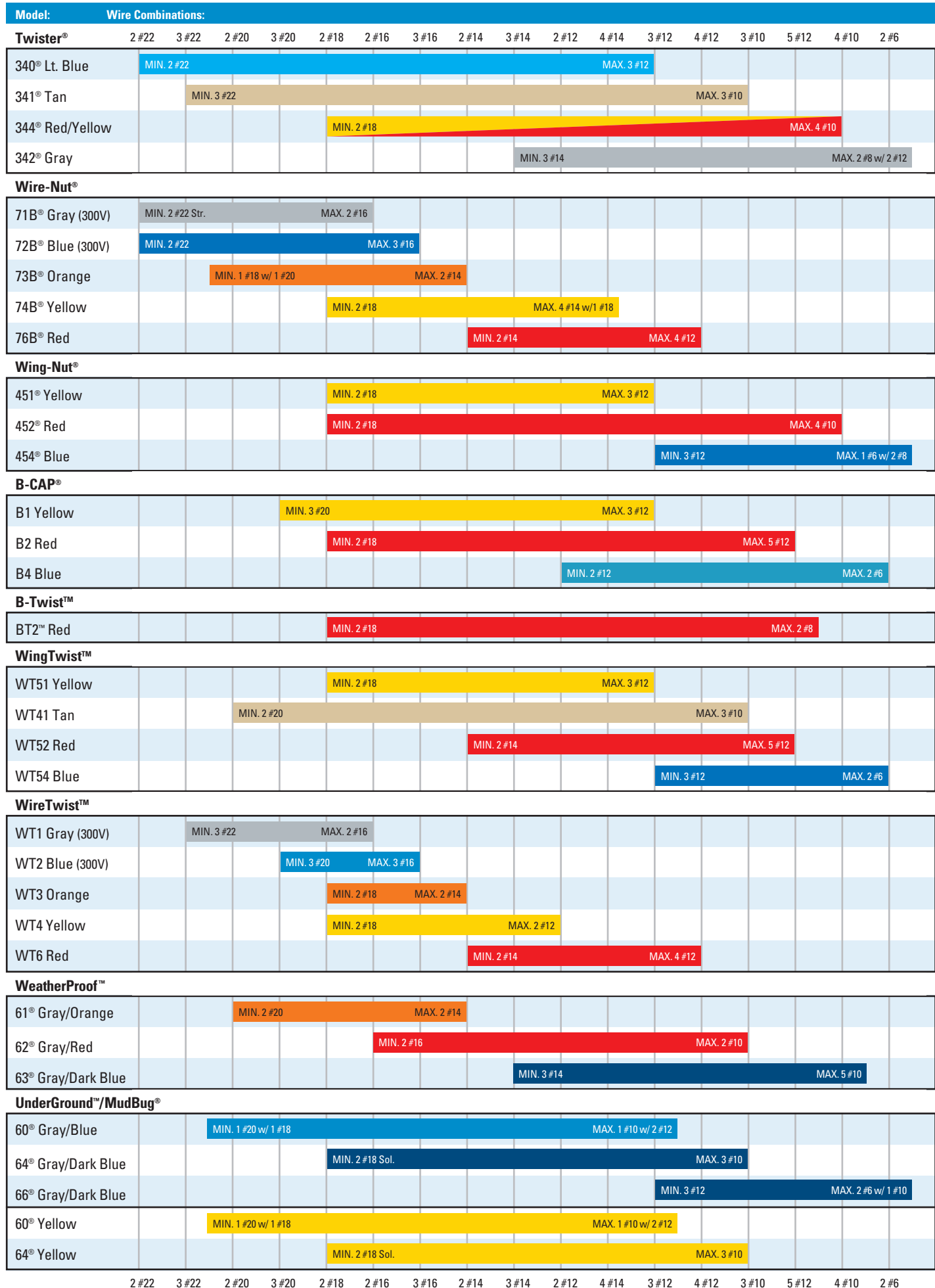

Comfort. Performance. Reliability.

Premium Wire Connectors

CLASSIC



**Wire-Nut®
Wire Connector**

The American **Classic** Since 1928.

POWER



**Wing-Nut®
Wire Connector**

Brings More **Power** with Every Twist.

COMFORT



**Twister®
Wire Connector**

More **Comfort**, Less Fatigue.

COMPACT



**B-CAP®
Wire Connector**

Compact Size, Wide Range.

FASTER



**B-Twist™
Wire Connector**

Comes to Torque **Quick** and Easy.